

# Puerta TIBET

## INSTRUCCIONES DE MONTAJE

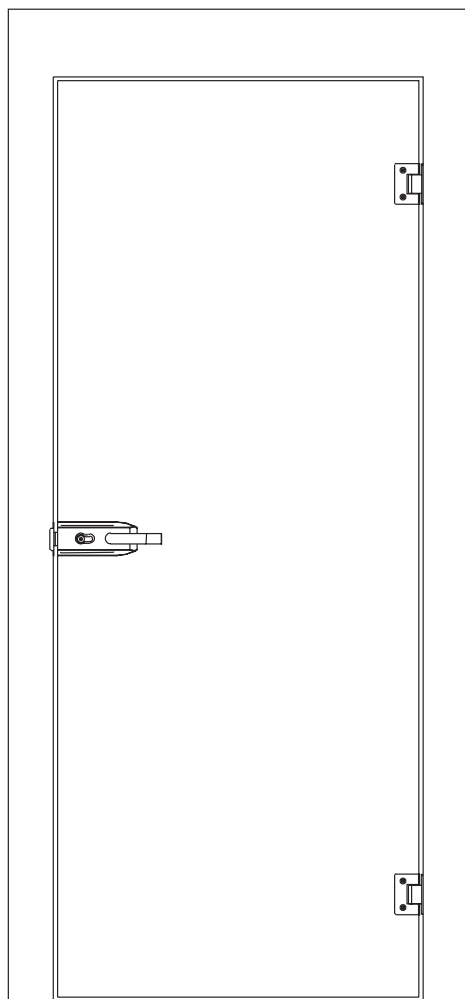

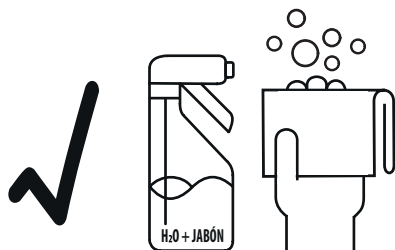
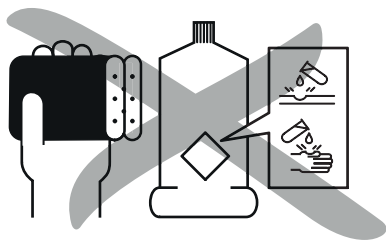

## NOTA IMPORTANTE\_ LIMPIEZA DE LA PUERTA

---

Limpié su puerta siempre con jabones neutros y agua.  
Otro tipo de productos pueden dañar serigrafías, gomas de estanqueidad, perfiles e incluso los tratamientos anticorrosivos de los cristales en caso de llevarlos.  
Limpiar siempre las piezas metálicas con un paño suave, no utilizar estropajos, provocaría arañazos.

1	JX2065	8
2	JX6002	8
3	Z-DOOR LOCKSET	1
4	S.S.304 HINGE	2
5	JX4022	1
6	BL2030*900*8	1
7	THE KEYS	5

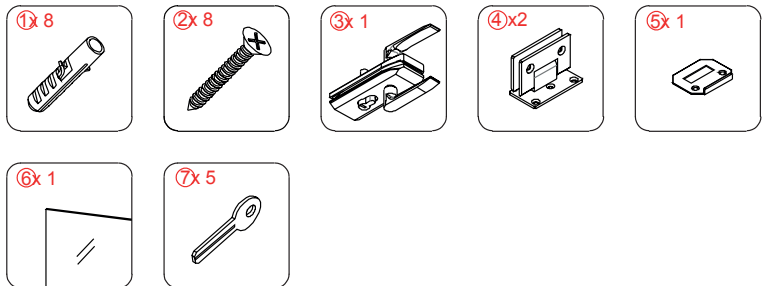
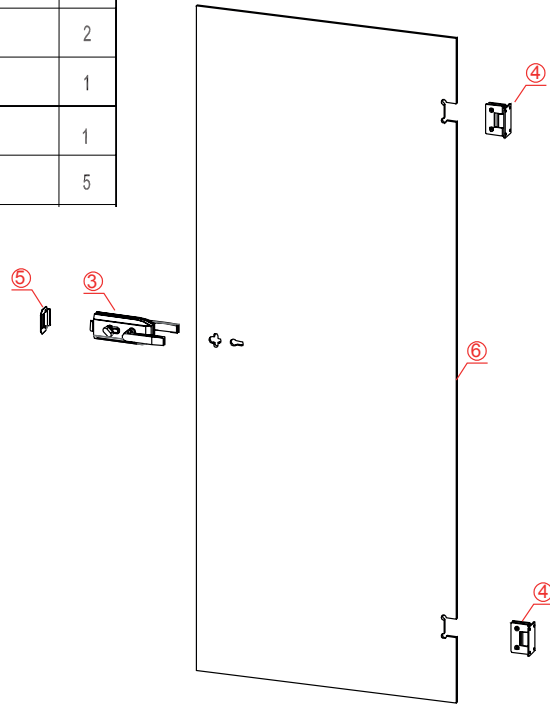

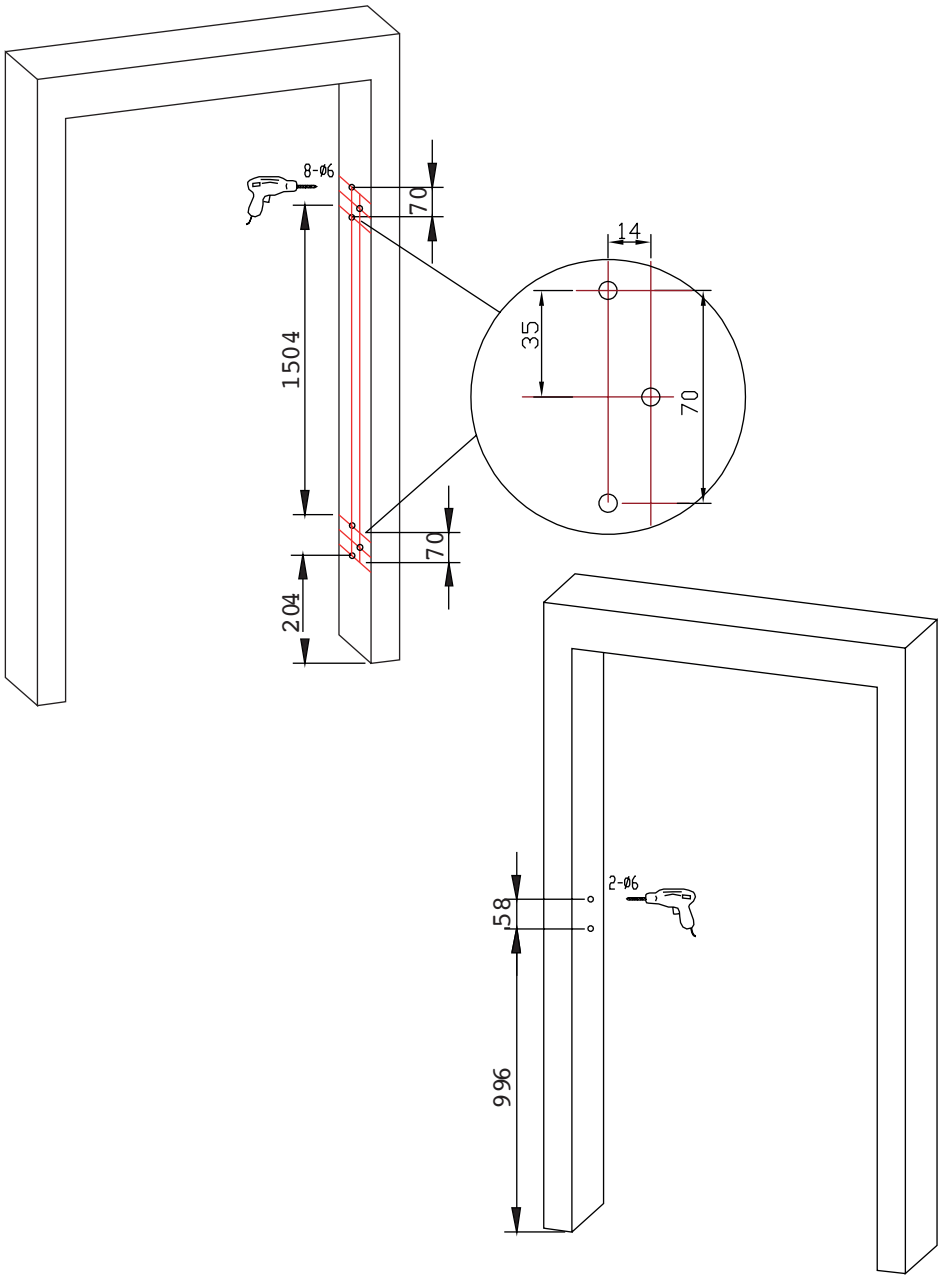

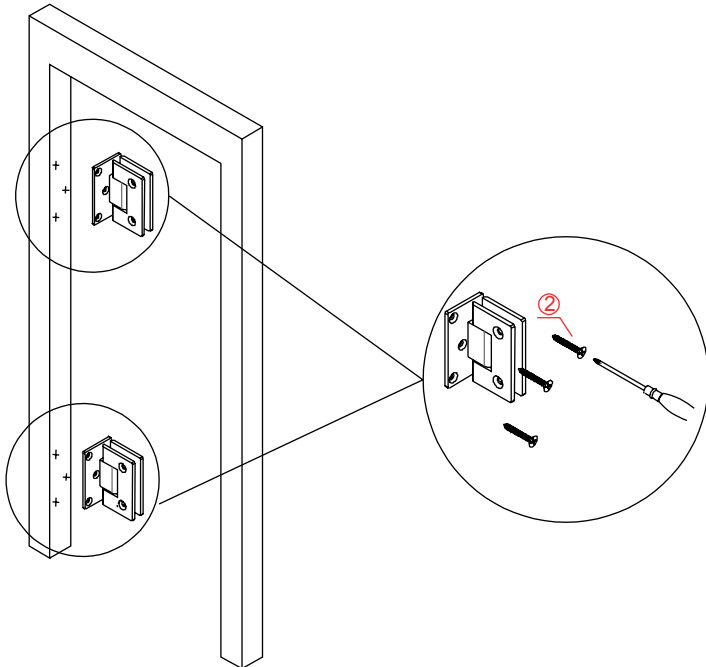
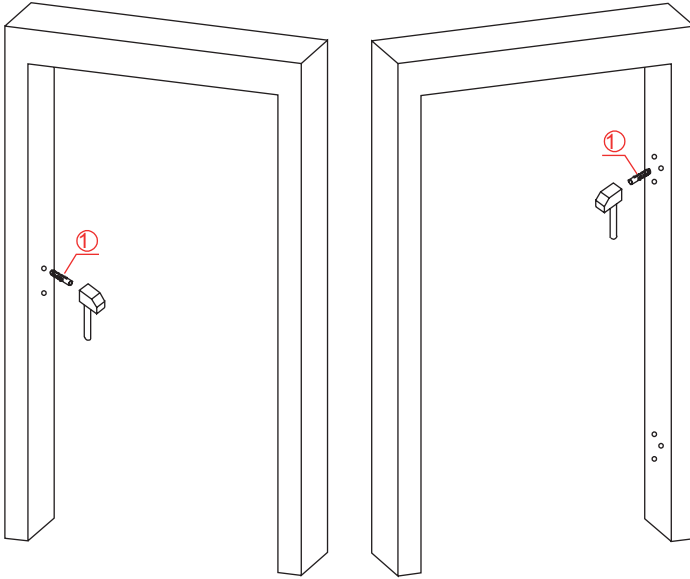

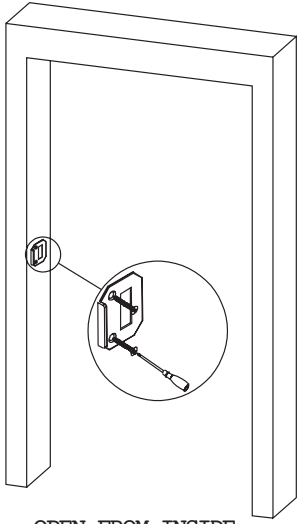

OPEN FROM INSIDE

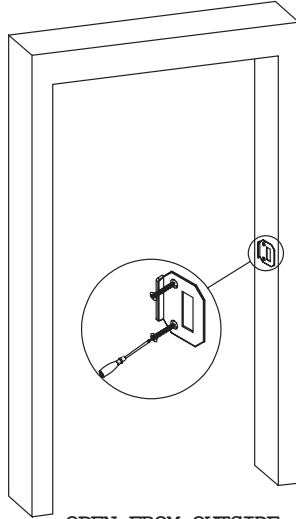

OPEN FROM OUTSIDE

